

## Operation & Installation Instructions



LUMINOR - Rack-Mount Systems								
SYSTEM	LB4-Z1 LB5-Z1	LB4-Z2 LB5-Z2	LB4-Z12 LB5-Z12	LBH4-Z2 LBH5-Z2	LBH4-Z12 LBH5-Z12	LBH4-Z22 LBH5-Z22	LBH4-Z122 LBH5-Z122	LBH4-Z222 LBH5-Z222
Rated Flow	8.0 GPM			15.0 GPM				
1st Filter	Sediment 10"	Sediment 20"	Sediment 10"	Sediment 20"	Sediment 10"	Sediment 20"	Mesh strainer 10"	Sediment 20"
2nd Filter	N/A	N/A	Carbon 20"	N/A	Carbon 20"	Carbon 20"	Sediment 20"	Scale reduction 20"
3rd Filter	N/A	N/A	N/A	N/A	N/A	N/A	Carbon 20"	Carbon 20"



**Congratulations on purchasing this LUMINOR UV system.**

## TABLE OF CONTENTS

Safety Considerations .....	4
Before You Begin .....	5
Water Quality Parameters .....	5
Assembly .....	6
Configuration Overview.....	7
System Sizing .....	8
Location .....	8
Orientation .....	9
Installation .....	10
System Preparation .....	13
Cleaning the Quartz Sleeve .....	13
Cleaning the UV Sensor .....	14
Filter Changes.....	14
Pressure Gauges .....	14
Cleaning the Mesh Strainer .....	15
Operation .....	16
BLACKCOMB <sup>4.1</sup> Controllers .....	17
BLACKCOMB <sup>5.1</sup> & BLACKCOMB <sup>6.1</sup> Controllers .....	17
BLACKCOMB <sup>5.1</sup> & BLACKCOMB <sup>6.1</sup> Power-up Sequence .....	17
BLACKCOMB <sup>5.1</sup> Operational Screens.....	18
BLACKCOMB <sup>6.1</sup> Operational Screens.....	18
Lamp Countdown Sequence .....	19
System Service Suggested.....	20
Lamp Replacement (BLACKCOMB <sup>4.1</sup> systems) .....	20
Lamp Replacement (BLACKCOMB <sup>5.1</sup> & BLACKCOMB <sup>6.1</sup> systems) .....	20
QR Codes .....	20
System Troubleshooting.....	21
Temperature Management Devices .....	22
Expansion Modules .....	23
BLACKCOMB Rack-Mount UV System Specifications .....	24
Limited Warranty Statement: .....	25
Warranty Registration .....	26

## Safety Considerations

It is important that care is taken when operating and/or maintaining your system.

### Please read the instructions

- The appliance is not to be used by persons (including children) with reduced physical, sensory or mental capabilities, or lack of experience and knowledge, unless they have been given supervision or instruction.
- Children should be supervised so that they do not to play with the appliance.
- **WARNING:** Do not operate the UV-C emitter when it is removed from the appliance enclosure.
- The appliance is to be supplied through a residual current device (RCD) having a rated residual operating current not exceeding 30 mA.
- This appliance contains a UV-C emitter.
- Unintended use of the appliance or damage to the housing may result in the escape of dangerous UV-C radiation. UV-C radiation may, even in little doses, cause harm to the eyes and skin.
- The appliance must be disconnected from the supply before replacing the UV-C emitter.
- The appliance is intended to be permanently connected to the water mains and not connected by a hose-set.
- Maximum working voltage of built-in UV driver U-OUT=240V
- If the supply cord is damaged, it must be replaced by the manufacturer, its service agent or similarly qualified persons in order to avoid a hazard.
- Before servicing this equipment, disconnect the power cord from the electrical outlet.
- Energy given off by the UV lamp is harmful to your eyes and skin. NEVER look directly at an illuminated UV lamp without adequate eye protection and always protect your skin from direct exposure to the UV light.
- For complete disinfection\*\*, use ONLY genuine replacement parts.
- Do not operate the unit if it has any damaged or missing components.
- To avoid possible electrical shock, use only with a properly grounded electrical outlet.
- Never perform any maintenance to the system unless you are comfortable in doing so. Contact the manufacturer for service instructions if required.
- Do not use this system for any purpose other than what it was intended for. Misuse of this system could potentially cause harm to the user or others.
- Your system is intended to be installed indoors and away from leaking plumbing. DO NOT plug the unit in if the system or any of the components are wet.
- The system should be directly installed into a ground fault circuit interrupter (GFCI). If the use of an extension cord is required, the cord must be manufactured with a minimum of 16 gauge wire and care should be taken to avoid potential tripping hazards.
- We recommend that a licensed plumber or certified technician install the system.

## Before You Begin

The following will be needed for installing the UV system:

### Tools

- Pipe cutter, hacksaw or other specialized tools required to cut into your existing plumbing (e.g. if you have PEX piping)
- Soldering tools (torch, flux, emery cloth and solder)
- Wrench (for tightening fittings)

### Other Materials

- Inlet/outlet connections
- Teflon™ tape

## Water Quality Parameters

Treated water should be tested for at the least the parameters listed below. If the water exceeds the listed parameters LUMINOR strongly recommends that appropriate pretreatment equipment be installed (equipment required will depend on parameters being treated):

**Hardness:** <7 gpg (120 mg/L) – if hardness level is 7 gpg or slightly below the quartz sleeve must be cleaned periodically in order to ensure efficient UV penetration; if above the water must be softened.

**Iron (Fe):** <0.3 ppm (0.3 mg/L)

**Manganese (Mn):** <0.05 ppm (0.05 mg/L)

**Turbidity:** < 1 NTU

**Tannins (organics):** <0.1 ppm (0.1 mg/L)

**UVT (transmittance):** >85% (Please contact LUMINOR if water has a UVT that is less than 80% for pre-treatment recommendations)

You can have your water tested at a private analytical laboratory or by your local dealer. It is always recommended to install pre-filtration of at least 5 microns prior to a LUMINOR UV disinfection\*\* system.

**\*\*LUMINOR's systems are tested for reduction of the MS-2 coliphage challenge microorganism to demonstrate a log reduction greater than or equal to the reduction caused by a dose of 40mJ/cm<sup>2</sup>.**

## Assembly

The BLACKCOMB rack-mount UV system is designed as a do-it-yourself (DIY) system with a single inlet and outlet port. Unpack the system and ensure all the components are included in the box. Your system is shipped with the following components:

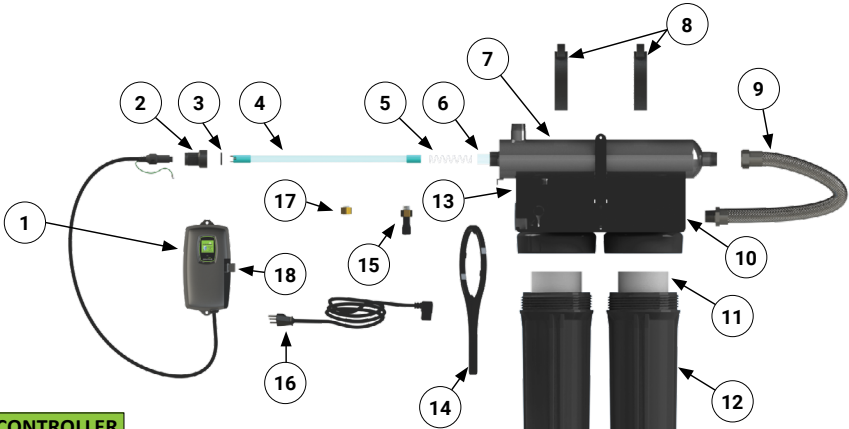

### 1 CONTROLLER

- RC-B4.01 (fits all 110V LB4 series units)
- RC-B4.02 (fits all 220V European (CEE 7/7), LB4 units)
- RC-B4.03 (fits all 220V British (BS 1363), LB4 units)
- RC-B4.04 (fits all 220V Australian (AS/NZS 3112), LB4 units)
- RC-B56.01 (fits all 110V LB5 series units)
- RC-B56.02 (fits all 220V European (CEE 7/7), LB5 units)
- RC-B56.03 (fits all 220V British (BS 1363), LB5 units)
- RC-B56.04 (fits all 220V Australian (AS/NZS 3112), LB5 units)
- RCHO-4.12 (fits all LBH4 series units)
- RCHO-56.12 (fits all LBH5 series units)

### 2 GLAND NUT

Part # 320006

### 3 O-RING

Part # 300038

### 4 UV LAMP

- RL-420 (fits LB5 series)
- RL-420HO (fits LBH5 series)

### 5 SLEEVE SPRING

Part # 310039

### 6 QUARTZ SLEEVE

RQ-420

### 7 UV REACTOR

Part # 300064

### 8 CLAMPS

Part # 390071 (each)

### 9 FLEXIBLE HOSE

- Part # 310130 (single filter)
- Part # 310126 (double filter)

### 10 MOUNTING PLATE

- Part # 310122 (for all single filter systems)
- Part # 310121 (for all double filter systems)

### 11 FILTER CARTRIDGES

- LC-10S 10" sediment cartridge
- LC-20S 20" sediment cartridge
- LC-20AC 20" high-capacity carbon cartridge
- LC-20WS 20" scale reduction cartridge
- LC-10MS 10" mesh strainer cartridge (Z122 models only)

### 12 FILTERS

- Part # 160049 (single filter, 10" sump)
- Part # 160050 (single filter, 20" sump)
- Part # 160051 (double filter, 10" & 20" sump)
- Part # 160052 (double filter, two 20" sumps)
- Part # 160053 (triple filter, self cleaning, & two 20" sumps)
- Part # 160054 (triple filter, three 20" sumps)

### 13 MOUNTING SCREWS

Part # 390083

### 14 FILTER WRENCH

Part # 160011

### 15 UV SENSOR

(optional module)

- RS-B3.5 (fits LB5 series)
- RSHO-B3.5 (fits LBH5 series)
- Sensor o-ring, Part # 310040

### 16 IEC POWER CABLE

(for use on LBH5 series only)

- 260004, North American Nema 5/15, 3 prong grounded
- 260005, European, 2-pin CEE 7/7 "Schuko"
- 260008, British, BS 1363, 3 prong grounded
- 260006, Australian, AS/NZS 3112, 3 prong grounded

### 17 GLOW PLUG

(on BLACKCOMB-HO<sup>®</sup> units only)

- Complete Assembly, Part # 300016
- Glow Plug, Part # 310026
- O-ring, Part # 310040
- Brass Nut, Part # 390007

### 18 LAMP KEY

- Comes with new UV lamps (NOT SOLD separately)
- Not for use on LB4/LBH4 systems

# Configuration Overview



**LB4-Z1**



**LBH5-Z22**



**LBH5-Z122**



**LBH5-Z222**

## System Sizing

All LUMINOR UV systems are rated for a specific flow rate in water that meets the quality parameters on page 5. PLEASE NOTE that increasing the flow above this rating or disinfecting\*\* water that does not meet the quality parameters will decrease the dose and therefore compromise the efficacy of the system. To determine the flow rate, follow these simple steps:

1. Be sure no water is being used in the home.
2. Open a faucet or tap nearest the pressure system and run until the well pump starts.
3. Close the faucet and using a second hand watch, record the length of time in seconds until the pump stops. This is known as the cycle time.
4. Then using a container of known volume, preferably in US Gallons, open the faucet or tap nearest the pressure system and measure the amount of water drawn off until the pump starts again. Depending on the size of the container used, it is acceptable to turn the faucet on and off to empty the container. This measurement is known as the draw down.

To calculate the pressure system flow rate divide the draw down by the cycle time and multiply that by 60.

**Draw Down** \_\_\_\_\_ ÷ **Cycle Time** \_\_\_\_\_ x 60 = \_\_\_\_\_ **Pumping Rate in USGPM**

## Location

Choose a location where the main cold water line is accessible. The system must be installed after other water treatment equipment (i.e. softener), but before any branches (See Figure 1).

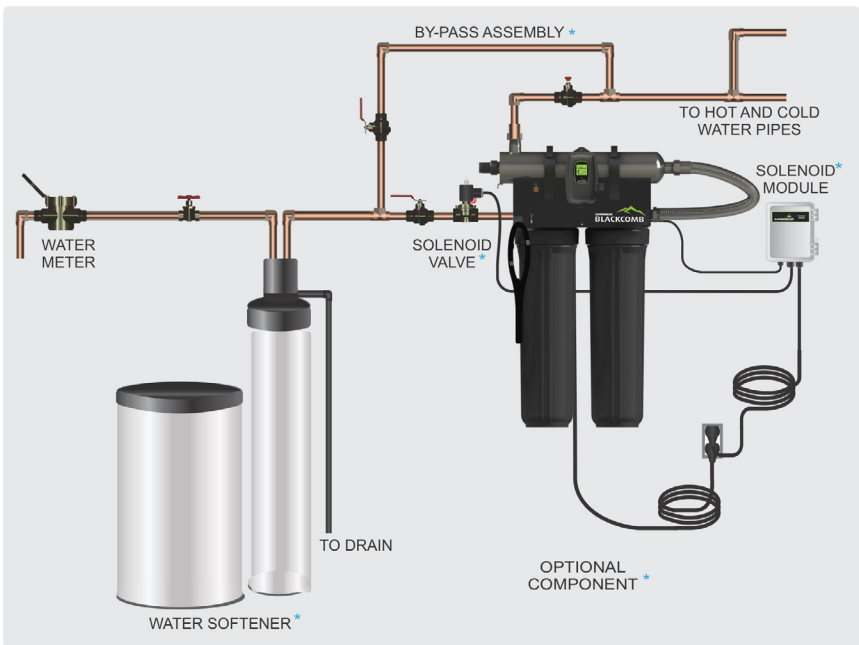

**Figure 1. Typical Installation**



**PLEASE NOTE:** All LUMINOR UV disinfection\*\* systems are intended for indoor use only as they should not be exposed to the elements. A ground fault circuit interrupter (GFCI or GFI) outlet is required.

## Orientation

This system has the ambidextrous capability of being able to have the main water inlet enter from either the left hand side or right hand side of the unit. The units comes pre plumbed from the factory for a left hand water inlet. To change to a right hand water inlet follow these simple steps (See Figure 2):

**Step 1:** Remove the filter sump housings (either one, two, or three housings depending on the model purchased) from the filter head and set aside.

**Step 2:** Remove the filter head screws from the top mounting plate.

**Step 3:** Carefully lower the filter head(s) from the rack assembly and rotate 180 degrees. Re-assemble onto the rack assembly and take note of the arrows located on the top of the filter head(s) indicating water flow (which now should be indicating a flow direction of right-to-left).



**Figure 2. System Orientation (water inlet)**

**Step 4:** Remove the stainless steel UV reactor from the two plastic clamps located on the top of the rack. Carefully remove the top straps securing the reactor with the aid of a standard (slot) screwdriver). Rotate the reactor 180 degrees (with the inlet now facing to the left and the lamp connections located towards the right) and place back into the cell clamps and re affix the two top straps.

In either the left or right configurations, to facilitate lamp removal, ensure there is enough space at the lamp connector end to safely remove the UV lamp and/or quartz sleeve (See Figure 3).

## Installation

**Step 1:** Once both the orientation and location have been selected, securely fasten the rack to a suitable backing. As the rack system is extremely heavy when filled with water, it is imperative that the rack be mounted with suitable fasteners for the particular installation. Mounting to a drywall backing is not suitable, unless the rack is fastened directly to the wall studs.

**Step 2:** The use of a by pass assembly is recommended as it will allow you to isolate the UV system. This will allow for easier access in case maintenance is required.

**Step 3:** For water supplies where the maximum flow rate is unknown, a flow restrictor is recommended so that the rated flow of your particular BLACKCOMB system is not exceeded. The flow restrictor should be installed on the inlet port of the reactor.

**Step 4:** It is recommended to have a licensed plumber connect the UV reactor to the water supply and may be a requirement depending on where you are located.

**Step 5:** Wrap the MNPT side of the flex hose with an appropriate amount of teflon tape. Install the flex hose by first tightening the MNPT side of the hose into the outlet of the filter housing. Be careful not to over tighten and crack the housing. After the MNPT side is tightened, connect the FNPT side of the hose to the stainless chamber. The gasket should compress and seal on the chamber.

**Step 6:** Connect both the inlet and outlet to the rack system with the applicable connections based on your particular plumbing requirements. The inlet port of the filters is a 1" FNPT connection and the outlet port of the UV reactor is a 1" MNPT connection.

**Step 7:** Once the system has been plumbed in, gently remove the quartz sleeve from its packaging being careful not to touch the length with your hands. The use of cotton gloves is recommended for this procedure as oils from the hands can leave residue on the sleeve and lamp which can ultimately block the UV light from getting to the water.

Carefully slide the sleeve into the reactor until you can feel it hit the opposite end of the reactor. Align the sleeve so it is centered along the length of the reactor, then gently push it in to lock it into the internal centering springs in the far side of the reactor. **CAUTION:** Pushing too hard when the sleeve is not aligned can damage the centering springs. Slide the o-ring onto the sleeve until it is butted up against the reactor (See Figure 4).

**Step 8:** Hand tighten the provided gland nut over the quartz sleeve onto the threaded end of the reactor. It has a positive stop to prevent over-tightening. A firm force may be required to fully tighten the gland nut, but **DO NOT USE TOOLS** for this step. Insert the provided stainless steel compression spring into the quartz sleeve. The spring works with the lamp and LUMI-Loc™ connector to create the proper lamp alignment. **PLEASE NOTE:** DO NOT install a UV lamp inside the quartz sleeve without the sleeve spring in place.

**Step 9:** Install the filter cartridges in their appropriate housings. For the BLACKCOMB branded products, please refer to the BLACKCOMB Rack-Mount UV System Specification chart.



**Figure 3. Lamp Removal Spacing**

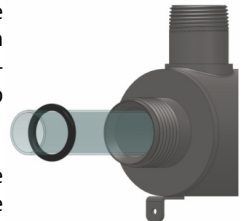

**Figure 4. Quartz Sleeve Installation**

**PLEASE NOTE:** This chart indicates the correct cartridge position for the default “left-hand” orientation with the water inlet located on the left side of the rack system. If the orientation was switched, the cartridge placement must also be switched. Once the cartridges are in place, use the supplied filter wrench to “snug” the filter housing onto the filter head (See Figure 5).



**Figure 5. Cartridge Removal**

**Step 10:** Install the optional UV sensor (**purchased separately**). Align the flat portion so it faces the gland nut end and matches up with the half metal lip on the sensor port (see Figure 6). Insert the sensor so it is fully seated and hand tighten the sensor nut. Insert the sensor connector into the IEP port located on the right side of the controller (Figure 7). For the sensor to be recognized by the controller, the controller power must be plugged in last. **Do not plug the controller power cord in before the last step.**



**Figure 6. UV Sensor Installation**



**Figure 7. IEP Connection**

**Step 11:** The system is now ready for water flow. **WARNING:** Sudden filling of an empty reactor could potentially break the protective quartz sleeves. It is strongly recommended to gradually fill the empty reactor. Damage because of sudden filling is not covered under warranty.

When all plumbing connections have been completed, slowly turn on the water supply and check for leaks. Make sure the bypass valves are functioning properly and that the water is flowing through the system. The most common leak is from the o-ring not making a proper seal on the reactor. For new installations, review steps 6 and 7. For older systems drain the reactor, remove the o-ring, dry it and reapply silicon grease. Reinstall the o-ring ensuring that it is properly sealed against the reactor and check again for leaks. To help vent the pressure from the system while the system is filling up with water, it is a good idea to twist open the pressure relief valve located on the top of the filter head. Close the valve once water appears at the port. If the system has two filters, perform this function on the housing closest to the water inlet first and then on the next filter in sequence.

**WATER-HAMMER WARNING:** Quartz sleeves can break inside the reactor if water-hammer occurs. Water hammer is caused by sudden closing of valves elsewhere in the piping system. It is strongly recommended to ensure that the piping and valve system is designed to prevent water-hammer. Damage due to water-hammer is not covered by warranty.

**Step 12:** Always hold UV lamps by their ceramic ends, not by the lamp quartz. Remove the lamp from its packaging. Again, the use of cotton gloves is recommended. Remove the lamp key from the lamp's connector and set it aside for the next step. Be careful not to touch the key's exposed contacts. Insert the UV lamp into the reactor, being careful not to drop it.

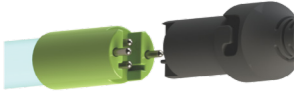

**Figure 8a. Standard Output UV Lamp Connection**

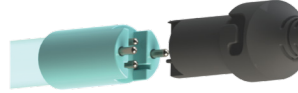

**Figure 8b. High Output UV Lamp Connection**

**Step 13:** Install the lamp key into the controller (**BLACKCOMB<sup>5.1</sup>, BLACKCOMB<sup>6.1</sup> systems only**). The key always comes packaged with the lamp and sits on the connector. With the key removed from the lamp, orient it so the label is upright and facing you. The key will plug into the lamp key port on the right side of the controller (Figure 9).

**Step 14:** Plug the LUMI-Loc™ lamp connector into the lamp. Note the keying for proper alignment (see Figure 8a, 8b). Insert the lamp connector into the gland nut and turn the connector approximately ¼ turn to lock the connector to the gland nut as in Figure 10.



**Figure 9. Lamp Key Installation**

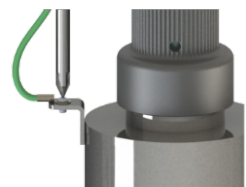

**Figure 10. LUMI-Loc™ Connector**

**Step 15:** Tighten the captive ground screw to the ground lug on the UV reactor to ensure proper grounding.

**Step 16:** Ensure all connections are sealed prior to pressurizing system, including factory connections.

**Step 17:** Your system is now ready to be plugged into the appropriate GFCI protected outlet. Refer to the following section before any water is allowed to flow through the system.



**Figure 11. Ground Screw Connection**

**Note:** Installation of your BLACKCOMB disinfection™ systems shall comply with applicable provincial/state & local regulations.

## System Preparation

With a new installation, or any time the UV system is shut down for service, without power, or is inoperative for any other reason, the lines in the home or facility could be contaminated. Use the following steps to prepare the lines throughout the entire home or facility.

**Step 1:** Check for and remove any “dead ends” in the lines throughout the home as these can harbor dirt and debris. Plug in the UV system and wait until it is ready for operation.

**Step 2:** Remove the filter cartridge from the last sump and fill it with 1-2 cups of household bleach (most are 5.25% chlorine). Replace the sump and slowly turn on the water supply.

**Step 3:** At a water outlet, run the water until bleach can be smelled. Repeat this for all faucets, toilets, shower heads, refrigerators, outdoor taps, the washing machine, dishwasher, etc. at the home or facility. Once finished, wait a minimum of 30 minutes before continuing.

**Step 4:** Reinstall the filter cartridge into the sump and flush the chlorine solution by opening all faucets until chlorine can no longer be detected. Your BLACKCOMB UV system is ready to use.

## Cleaning the Quartz Sleeve

Depending on the water quality, the quartz sleeve may require periodic cleaning. At a minimum, the quartz sleeve should be cleaned on an annual basis. The following steps outline a basic cleaning procedure.

**Step 1:** If a bypass assembly is installed, shut the inlet valve off to prevent water flow through the system. Otherwise, turn off main water inlet valve (and/or turn off the water pump).

**Step 2:** Disconnect power cord of UV system from electrical outlet.

**Step 3:** Release water pressure by opening a downstream faucet and then close the outlet shut-off valve (if any). If there is no outlet shut-off valve, expect water to drain from the system as the head pressure in the system will cause the water to flow back down.

**Step 4:** Remove the captive ground screw from the ground lug on the UV reactor.

**Step 5:** Remove the lamp connector from the reactor (gland nut) by pushing the LUMI-loc connector in and turning it ¼ turn counter-clockwise. Disconnect the lamp connector from the lamp. CAUTION: the lamp may be hot!

**Step 6:** Being careful to touch only the ceramic ends, remove the lamp out of the reactor.

**Step 7:** Unscrew the gland nut from the reactor exposing the end of the quartz sleeve.

**Step 8:** Remove the quartz sleeve and o-ring by **gently twisting and pulling** the quartz sleeve.

**Step 9:** Using a soft, lint-free cloth or towel wipe the sleeve down using a commercial scale cleaner (i.e. CLR® or LIME-A-WAY®). This removes scaling or iron deposits that may be on the outside of the quartz sleeve. Be careful not to get any moisture or liquids inside of the sleeve.

**Step 10:** Dry the sleeve with separate cloth.

**Step 11:** Replace the o-ring and slide the sleeve back into the reactor following steps 7 and 8 from the installation section of the manual.

## Cleaning the UV Sensor

Depending on the water quality, the UV sensor may require periodic cleaning. At a minimum, the UV sensor should be cleaned on an annual basis. The following steps outline a basic cleaning procedure.

- Step 1:** If a bypass assembly is installed, shut the inlet valve off to prevent water flow through the system. Otherwise, turn off main water inlet valve (and/or turn off the water pump).
- Step 2:** Disconnect power cord of UV system from electrical outlet.
- Step 3:** Release water pressure by opening a downstream faucet and then close the outlet shut-off valve (if any). If there is no outlet shut-off valve, expect water to drain from the system as the head pressure in the system will cause the water to flow back down.
- Step 4:** Place something under the reactor to catch any water that may come out of the reactor during the removal of the UV sensor.
- Step 5:** Unscrew (counterclockwise) sensor nut from the reactor and pull the sensor slowly out of the sensor port.
- Step 6:** Holding the sensor in your hand wipe the flat portion (sensor face) of the sensor with isopropyl alcohol using a clean lint-free cloth.
- Step 7:** Replace sensor following step 9 from the installation section of the manual.

## Filter Changes

### Activated Carbon Cartridge

For devices containing activated carbon technology, the filter cartridges should be replaced after six months of use. Carbon filters have the potential for bacteriological contamination, and they should be changed after six months regardless of actual water usage.

### Sediment Cartridge

For most installations, the filters included with your BLACKCOMB UV Rack system are designed to be changed in conjunction with the UV lamp. In some applications, for example with high sediment or iron content, the filters may need to be changed more frequently based on pressure drop. Filtration cartridges become loaded (plugged over time and it is this loading that leads to a drop in water pressure. Typically, filters should be changed with the service pressure (the available water pressure when water is being drawn) reaching 20-30 psi or a pressure drop of 10-15 psi. This endpoint may be different depending on the specific application and pressure requirements. For example, an occupant of a three-story house may notice low water pressure earlier on the third story than the first floor.

### Surface Type Cartridge

If your system is equipped with a surface type cartridge, the filter should be washed on a regular basis to maintain performance. If the filter is only slightly dirty, the filter can be cleaned without depressurizing the system. A hose should be connected to the drain port at the bottom of the first, clear filter, and then the valve can be opened and closed quickly. Water will flow in reverse through filter and out the drain while the valve is opened. **CAUTION:** Water will exit this drain extremely quickly. If extreme loading of the filter is observed, the filter should be removed from the housing and washed.

## Pressure Gauges

Your BLACKCOMB UV Rack system is equipped with pressure gauge ports to monitor the pressure drop across each specific filter. Depending on the application it may be important to monitor pressure drop across one, two or all three filters. A pressure gauge should be installed before and after each filter being monitored.



## Cleaning The Mesh Strainer (Z122 models only)

This system contains a washable mesh filter that is designed to prolong the life of your subsequent filters. Actual water quality will impact required cleaning frequency. The filter is designed to be cleaned in place without turning off the water supply or depressurizing the system.

**Step 1:** Ensure that an appropriate drain line or bucket is below the system. The drain line should be no more than 2m (6ft) in length.

**Step 2:** Open the drain valve for 15-20 seconds. This generates a pressure-drop in the filter that pushes the cartridge downward, automatically reversing water flow from the inside (counter-current) out of the cartridge. This water flow in counter-current carries particles and substances deposited on the cartridge to drain.

**Step 3:** Close the valve. After a couple of seconds, the internal spring will return the cartridge to its service position.



**Figure 12. LBH5-Z122 system drain port**

If contamination is significant, the previous steps may not be sufficient to fully clean the filter cartridge. In this case:

**Step 1:** Shut off water flow upstream and downstream of the system.

**Step 2:** Open the drain valve and vent(s) to drain the water from the system.

**Step 3:** Open the filter by unscrewing the sump from the head using the supplied wrench.

**Step 4:** Remove the cartridge, being careful not to lose the spring.

**Step 5:** Clean the cartridge under a jet of cold water and use a soft brush to remove impurities.

**Step 6:** Insert the clean cartridge back in the sump.

**Step 7:** Screw the sump to the head.

**Step 8:** Close the vent(s) and drain ports.

**Step 9:** Slowly open the inlet valve into the system, then open the outlet valve once the system is pressurized. If any damage is observed on the filter, it should be replaced.

## Filter Housing Drain Plug

In order to remove all water from the filter housing, unscrew the drain plug from the underside of the housing.



**Filter housing drain plug**

## Operation

BLACKCOMB systems come with a feature laden controller that incorporates both the lamp driver (ballast) and control features in one water-tight case. Four main controllers are available for the BLACKCOMB systems (depending on your model). All four models feature a power factor corrected, constant current lamp driver with a universal power input.

Please Note: While the LED or display screen is red and the buzzer is sounding the water from the system should NOT be consumed. If any water does pass through the system during this period, please follow the disinfection\*\* procedure as outlined in this manual before the water is consumed. For BLACKCOMB<sup>4.1</sup> and BLACKCOMB<sup>5.1</sup> systems, even though they have a visual and audible warning built into the controller, a green LED or status screen does not necessarily indicate that the water coming from this system is in fact potable (safe to drink). These systems do not measure the level of disinfection\*\*; they simply measure the “on-off” status of the lamp. Please have your water checked for microbiological contaminants on a regular basis.



## BLACKCOMB<sup>4.1</sup> Controllers



**LB4  
Series**



**LBH4  
Series**

Simplistic in operation, these systems feature a tri-colour LED that indicating system status and a 4-digit display to indicate lamp life remaining. Pressing the button will change the display to indicate total running time. When the UV lamp is on and within its operating age, the LED will be green. When the UV lamp is not on or the lamp life has expired, the LED will be illuminated red and an audible buzzer will be sounding. To remedy this condition, the UV lamp must be replaced with a new genuine LUMINOR UV lamp.

## BLACKCOMB<sup>5.1</sup> & BLACKCOMB<sup>6.1</sup> Controllers



**LB5 / LB6  
Series**



**LBH5 / LBH6  
Series**

A full colour LCD screen provides the user with a detailed description of the system's performance in addition to providing any applicable fault messages and system diagnostics. The controllers used in both the BLACKCOMB<sup>5.1</sup> and BLACKCOMB<sup>6.1</sup> are identical. The difference is that the BLACKCOMB<sup>6.1</sup> series of products includes a UV intensity monitor. All BLACKCOMB<sup>5.1</sup> and BLACKCOMB<sup>6.1</sup> controllers include an "infinite expandability port" located on the right side of the controller. Simply plug in an optional UV sensor module into the expandability port of a BLACKCOMB<sup>5.1</sup> controller and the system will now monitor the UV intensity of the system!

## BLACKCOMB<sup>5.1</sup> & BLACKCOMB<sup>6.1</sup> Power-up Sequence

On start up, the controller will run through a diagnostic start-up and the sequence will be displayed as follows on the colour LCD:



Next, the controller checks for and initializes any optional modules that may be attached to the system.

## Optional Modules Check

-  - UV Sensor
-  - Solenoid
-  - 4-20 mA
-  - WIFI
-  - Remote Alarm
-  - Flow Meter

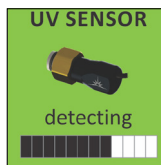

OR

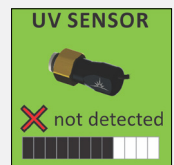

A final module screen is displayed showing which specific modules were initialized.

The controller then displays the lamp optimization screen for 60 seconds to allow the lamp to reach its optimum output. Finally, a final “start-up complete” screen is displayed. The system will now be ready to disinfect\*\* water flow.



all detected modules



lamp reaching max output

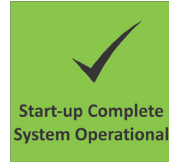

successful start-up

## BLACKCOMB<sup>5.1</sup> Operational Screens

On systems without the UV monitor, the default screen shows the **LUMINOR Home Screen**. At any point during operation the user is able to scroll through the **LUMINOR Home Screen, Lamp life remaining, QR Code, Contact Info and Maintenance Parts** screens by pressing the button located on the front of the controller.



## BLACKCOMB<sup>6.1</sup> Operational Screens

On systems with the UV monitor, the system will display the same screens as on the BLACKCOMB<sup>5.1</sup> except the UV Intensity replaces the home screen. The UV Intensity screen displays the level of UV light detected by the sensor. UV intensity can be affected by poor water quality, scaling on the quartz sleeve and/or sensor, lamp failure or lamp expiring. The following screens show the UV Intensity dropping.

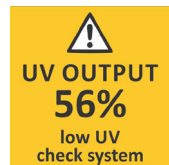
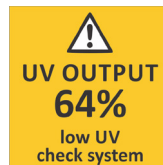

Below 56%, the numbers and warning sign turn red and an audible chirp is given by the ballast every 15 seconds. Below 51%, the screen is solid red and a constant audible alarm is given. This alternates with a screen indicating “water may be unsafe for consumption”. With the solenoid module, the controller de-activates the solenoid valve, shutting off all water flow.

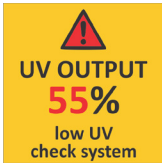

audible chirp every 15 seconds

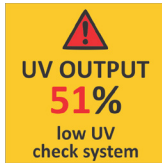

audible chirp every 15 seconds

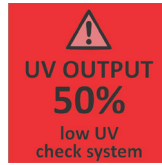

constant audible alarm



cycles with red low UV screen

### Lamp Countdown Sequence

The system counts down the number of days until a lamp change is required.

BLACKCOMB<sup>6.1</sup>  
BLACKCOMB<sup>5.1</sup>



BLACKCOMB<sup>4.1</sup>



At thirty days remaining, the LED or display screen will change to a yellow caution indicator. At seven days remaining, the system will additionally repeat an audible chirp. Past the zero day threshold, the LED or display screen changes to solid red with a continuous buzzer.

BLACKCOMB<sup>6.1</sup>  
BLACKCOMB<sup>5.1</sup>



BLACKCOMB<sup>4.1</sup>



At any point during this sequence, the audible chirp or alarm can be deferred for seven days by holding the controller button down for a period of five seconds. The number of deferrals used will be displayed as below. Once the deferral expires, the alarm will sound once again. The deferral can be repeated up to three times. **PLEASE NOTE:** At any point after lamp expiration, the water may be unsafe for consumption and should not be consumed without another form of disinfection\*\*.



## System Service Suggested

BLACKCOMB 5.1 & 6.1 controllers will display the System Service Suggested Screen every 6 months to remind consumers to maintain both their UV and other prefiltration. This will serve as a prompt only and will not put the system into alarm. To clear this condition simply press the button located below the screen.

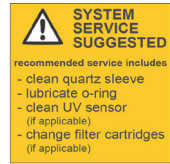

### Lamp Replacement (BLACKCOMB<sup>4.1</sup> systems)

After the lamp is expired, it must be replaced with the same part number as indicated by the label on the reactor. Begin replacing the lamp by unplugging the power for the controller, then refer to **Installation**, starting with step 11 (page 11) for instructions on installing the new lamp. To reset the timer in the controller, firmly hold down the button on the controller for 10 seconds. The controller will read “rSt3”, “rSt2”, “rSt1” and then beep. The button can now be released, the lamp countdown timer has been reset.

### Lamp Replacement (BLACKCOMB<sup>5.1</sup> & BLACKCOMB<sup>6.1</sup> systems)

After the lamp is expired, it must be replaced with the same part number as indicated on the Maintenance Parts screen or on the label on the reactor. With the system powered down, remove and discard the lamp key from the controller. The replacement lamp is packaged with a lamp key on the connector at the end of the lamp. Remove the key from the lamp and place it in the controller. Refer to **Installation**, starting with step 11 (page 11) for instructions on installing the new lamp.



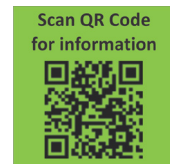

## QR Codes

A **QR code** (Quick Response code) is a matrix barcode first designed for the automotive industry. LUMINOR uses the QR code to store a link to a specific page on our website. Users with a camera phone equipped with the correct reader application can scan the image of the QR code and over a wireless network connect to a LUMINOR web page in the phone’s browser. LUMINOR’s QR webpage has information on how to purchase replacement components as well as a helpful video directory on system servicing (i.e. How to change a UV lamp or quartz sleeve). To access the QR code on the BLACKCOMB controller, press the control button until the QR code screen appears.





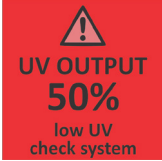
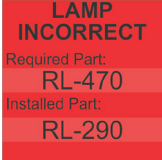

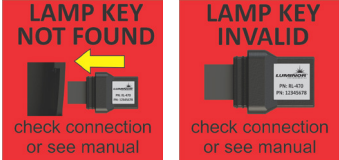



## System Troubleshooting

**Hard Alarms:** The following give a constant audible alarm. If present, the solenoid valve is closed, and the 4-20, remote alarm and Wifi modules transmit the alarm.

System Display	Problem	Resolution
	The system has detected a problem with the lamp.	Reset lamp protection circuit -unplug unit for 10 seconds. Replace the lamp with the part as indicated on the silver label on the reactor or on the Maintenance parts screen.
	Although the lamp is powered and visibly illuminated, due to the lamp's age its UV output is no longer sufficient for proper disinfection**.	Replace the lamp with the part as indicated on the silver label on the reactor or on the Maintenance parts screen.
	Low UV Intensity.	Remove and clean the quartz sleeve and sensor. Check water quality meets requirements on page 5 and add filtration as required. Replace lamp.
	Wrong lamp or sensor installed.	Replace component with proper model as indicated.
	The UV sensor is no longer communicating to with the system.	Ensure all modules are connected properly to the system and to each other.  Modules can be tested individually by plugging in one at a time and cycling power to the system.
	A bad connection has been detected in the IEP port.	Replace any module that is not detected when plugged directly into the controller.
	Missing or incorrect lamp key.	Ensure the lamp key (packed with the lamp, on the connector) is installed. Unplug and reinstall the key. Ensure the key part number matches Lamp on Maintenance Parts screen.

**Soft Alarms:** The following remaining errors give a 15 second audible chirp only

System Display		Problem	Resolution
 <p><b>SOLENOID FAILURE</b></p>  <p>check connection or see manual</p>	 <p><b>4-20 mA FAILURE</b></p>  <p>check connection or see manual</p>	<p>The module indicated is no longer communicating to with the system.</p>	<p>Ensure all modules are connected properly to the system and to each other.</p> <p>Modules can be tested individually by plugging in one at a time and cycling power to the system.</p> <p>Replace any module that is not detected when plugged directly into the controller.</p>
 <p><b>REMOTE ALARM FAILURE</b></p> <p>check connection or see manual</p>	 <p><b>WIFI FAILURE</b></p> <p>check connection or see manual</p>		
 <p><b>FLOW METER FAILURE</b></p> <p>check connection or see manual</p>	 <p><b>LUMINOR ERROR</b> Flow Rate <b>FULL POWER</b></p>	<p>Refer to flow meter manual for detailed troubleshooting</p>	

**Warning:** After any hard alarm, the home or facility should be disinfected\*\*. Follow the steps under the “System Preparation” heading.

**Boil Water Advisory:** If any failure occurs on a BLACKCOMB UV system, the water must not be used for human consumption until the system is returned to a safe operational mode. If the water is used for human consumption during this period, the water must be boiled (minimum 20 minutes at a full boil) prior to consumption.

### Temperature Management Devices

Your LUMINOR BLACKCOMB system is designed to run continuously to ensure optimal disinfection\*\*. However, during periods when no water is drawn through the system, the energy from the disinfection\*\* process can cause the temperature of the water inside the chamber to rise. In extreme situations elevated water temperature or the fluctuation in temperature can lower the output of the UV lamp. In these cases, or if the elevated water temperature is a nuisance, LUMINOR recommends one of the following forms of temperature management devices.



#### Cooling Fan

Designed for use on the BLACKCOMB-HO systems, the “LUMI-cool™” fan runs continuously to cool the water by forced convection. The long-life fan is powered independently using a compact modular power adapter that operates from 90-265V (47-63Hz). Order PN **130014** (only fits LBH4/LBH5 systems).



#### Temperature Relief Valve (TRV)

On reaching a higher temperature, the TRV is designed to drain a small amount of water to allow fresh, cooler water to enter the system. The TRV works without power and comes complete with 10’ of drain line. Order PN **130033** for 1” ports.

## Expansion Modules



BLACKCOMB<sup>5.1</sup> and BLACKCOMB<sup>6.1</sup> controllers incorporate an “**Infinite Expandability Port**” (IEP) which allows for expansion to the UV sensor and all other modules. Each module (including the sensor) comes with both a male and female connection. Connect any device to the controller and all subsequent devices are then connected into the female end of last device added in a “daisy chain” configuration.

The following optional expansion modules are available for use on BLACKCOMB UV controllers. Contact your authorized distributor for purchasing information.



**REMOTE ALARM CONNECTION MODULE:** Allows for a connection to a remote device such as a buzzer, light, alarm system, PLC, etc., via a pair of contacts. In normal operation the OK and COM contacts will be connected, and in a fault condition (Low UV, Lamp fail, Power Fail), the Fault and COM contacts will be connected. Maximum contact rating is 30V / 1A (use 16-22 AWG). Order PN **MOD-RAM**.



**SOLENOID CONNECTION MODULE:** Connects a NORMALLY CLOSED line voltage solenoid valve to the controller. Maximum contact rating is 240VAC (50-60Hz) / 30VDC / 2A. On a non-monitored system, the solenoid will only close on a lamp failure error. On a monitored system, the solenoid is closed when the UV level drops below 50%. Also note that in cases where emergency use of untreated water is required, the controller can be placed into a manual override mode allowing for the flow of water in an alarm condition. Order PN **MOD-SOL**.



**4-20 mA MODULE:** Outputs a 4-20mA signal of the UV output to a remote device such as a data logger or computer. Order PN **MOD-420**.



The **WiFi module** and accompanying **IoT** application allows you to connect your UV system to a smart phone, tablet, computer or other connected platform. View system status, receive SMS or email messages of alarm conditions and monitor the health of your UV from anywhere via this connected platform. Connect the device via the APP found on Google Play or the APP Store. Connect your UV device to your router, download the software for your connected device and have peace of mind that your UV system is fully operational.

The **Ultrasonic Flow Meter** enables your UV system to dim power in times of low to no flow, saving you money on energy, reducing water temperature, and decreasing the risk of fouling.

## BLACKCOMB Rack-Mount UV System Specifications

	LUMINOR EQUIPMENT SPECIFICATIONS							
	RACK-MOUNT UV SYSTEMS							
MODEL	LB4-Z1 LB5-Z1	LB4-Z2 LB5-Z2	LB4-Z12 LB5-Z12	LBH4-Z2 LBH5-Z2	LBH4-Z12 LBH5-Z12	LBH4-Z22 LBH5-Z22	LBH4-Z122 LBH5-Z122	LBH4-Z222 LBH5-Z222
Flow Rate (30mJ/cm <sup>2</sup> @ 95% UVT)	8.0 GPM			15.0 GPM				
	30.3 lpm			56.8 lpm				
	1.82 m <sup>3</sup> /hr			3.4 m <sup>3</sup> /hr				
Flow Rate (@40mJ/cm <sup>2</sup> )	5.6 gpm			12 gpm				
	21.2 lpm			45.4 lpm				
	1.3 m <sup>3</sup> /hr			2.7 m <sup>3</sup> /hr				
1st Filter Housing	5 micron sediment <b>LC-10S</b>	5 micron sediment <b>LC-20S</b>	5 micron sediment <b>LC-10S</b>	5 micron sediment <b>LC-20S</b>	5 micron sediment <b>LC-10S</b>	5 micron sediment <b>LC-20S</b>	90 micron mesh strainer <b>LC-10MS</b>	5 micron sediment <b>LC-20S</b>
2nd Filter Housing	N/A	N/A	High- capacity carbon <b>LC-20AC</b>	N/A	High- capacity carbon <b>LC-20AC</b>	High- capacity carbon <b>LC-20AC</b>	5 micron sediment <b>LC-20S</b>	Scale reduction <b>LC-20WS</b>
3rd Filter Housing	N/A	N/A	N/A	N/A	N/A	N/A	High- capacity carbon <b>LC-20AC</b>	High- capacity carbon <b>LC-20AC</b>
Port Size	1" MNPT							
Electrical	90-265V/50-60Hz.							
Plug Type	American, NEMA 5-15, no suffix (i.e. LB5-Z1) European, CEE 7/7, "2" suffix (i.e. LB5-Z1-2) British Standard, BS 1363, "3" suffix (i.e. LB5-Z1-3) Australian/New Zealand, AS/NZ 3112, "4" suffix (i.e. LB5-Z1-4)							
Lamp Power (Watts)	20 (standard-output lamp)			45 (high-output lamp)				
Power (Watts)	23 (21 @ 230V.)			57 (48 @ 230V.)				
Replacement Lamp	RL-420			RL-420HO				
Replacement Sleeve	RQ-420							
Reactor Dimensions	8.9 x 50.8 cm (3.5 x 20")							
Chamber Material	Polished 316L stainless steel, A249 pressure rated tubing							
Controller Dimensions	17.2 x 9.2 x 10.2 cm (6.8 x 3.6 x 4")			21.7 x 10.8 x 10.2 cm (8.6 x 4.2 x 4")				
Operating Pressure	0.7-8.3 bar (10-120 psi)							
Operating Water Temperature	2-40° C (36-104° F)							
UV Monitor	Optional (requires additional UV sensor module) ( <b>RS-B3.5 on LB5 units &amp; RSHO-B3.5 on LBH5 units</b> )							
Solenoid Output	YES (but requires optional solenoid module) ( <b>MOD-SOL</b> )							
Dry Contacts	YES (but requires optional remote alarm module) ( <b>MOD-RAM</b> )							
4-20mA Output	YES (but requires optional 4-20mA module) ( <b>MOD-420</b> )							
Lamp Change Reminder	YES (audible & visual)							
Lamp Out Indicator	YES (audible & visual)							
Shipping Weight	11.36 kg (25 lbs)	12.45 kg (27.4 lbs)	18.45 kg (40.6 lbs)	12.82 kg (28.2 lbs)	18.82 kg (41.4 lbs)	20.18 kg (44.4 lbs)	23.13 kg (51 lbs)	27.21 kg (60 lbs)

Add suffix "-NC" to model number for No Cartridges



## Limited Warranty Statement:

Products manufactured by LUMINOR Environmental Inc., (LUMINOR) are warranted to the original user only to be free of defects in material and workmanship for a period as specified below. This warranty only applies to the original purchaser and is not transferable.

### UV SYSTEMS

Ten (10) year Limited Warranty on the stainless steel reactors, from the date of original purchase, or installation (proper documentation required for verification).

### ELECTRONICS

Three (3) year Limited Warranty on the ballasts and controllers, from the date of original purchase, or installation (proper documentation required for verification).

### UV LAMPS, UV SENSORS & QUARTZ SLEEVES

One (1) year Limited Warranty on all LUMINOR ultraviolet lamps, UV sensors and quartz sleeves from the date of original purchase, or installation (proper documentation required for verification).

LUMINOR warrants that it will repair, replace or refund, at LUMINOR's sole option, any ultraviolet system or component that is defective in materials or workmanship for the period as outlined above, subject to the "Limitations of Warranty" as outlined below. LUMINOR's liability under this warranty shall be limited to repairing or replacing at LUMINOR's option, without charge, F.O.B. LUMINOR's factory or authorized service depot, any product that LUMINOR manufactures. LUMINOR will not be liable for any costs of removal, installation, transportation, or any other charges which may arise in connection with a warranty claim. Products which are sold but not manufactured by LUMINOR are subject to the warranty provided by the manufacturer of said products and not by LUMINOR's warranty. LUMINOR will not be liable for damage or wear to products caused by abnormal operating conditions, accident, abuse, misuse, unauthorized alteration or repair, or if the product was not installed in accordance with LUMINOR's printed installation and operating instructions.

## LIMITATIONS OF WARRANTY

This warranty does not apply to any of the following:

- Water Quality Parameters lie outside of the following ranges
  - Hardness > 120 mg/L (7 gpg)
  - Iron > 0.3 mg/L (ppm)
  - Manganese > 0.05 mg/L (ppm)
  - Tannins > 0.1 mg/L (ppm)
  - Turbidity > 1 NTU
  - Transmittance (UVT) < 75%
- A product that has been incorrectly installed according to the owners manual.
- A product that has been modified in any manner, unless approved by the manufacturer.
- A product where the serial number has been altered defaced or removed.
- Damage caused by the use of parts that are not compatible, suitable and/or authorized by LUMINOR for use with the product (e.g. non-original lamps or sleeves).
- Damage caused during shipment of the product.
- Water damage is found inside ballast housing or controllers.
- Product is installed outdoors in direct contact with the environment (rain).
- Product is installed in freezing temperatures.
- Product is used in conditions that exceed LUMINOR's specifications.

## TO GET WARRANTY SERVICE

To obtain service under this warranty, you must first contact where the product was originally purchased to obtain a Warranty Return Authorization. You will require proof of purchase and installation date, failure date, and any other requested data. Unless otherwise provided, the Dealer or Distributor will contact LUMINOR for instructions on returning the product. Any defective product to be returned to LUMINOR must be sent freight prepaid; documentation supporting the warranty claim and/or a Return Goods Authorization must be included if so instructed.

LUMINOR WILL NOT BE LIABLE FOR ANY INCIDENTAL OR CONSEQUENTIAL DAMAGES CAUSED BY FIRE, FLOOD, OR ACTS OF GOD, LOSSES, OR EXPENSES ARISING FROM INSTALLATION, USE, OR ANY OTHER CAUSES. THERE ARE NO EXPRESS OR IMPLIED WARRANTIES, INCLUDING MERCHANTABILITY OR FITNESS FOR A PARTICULAR PURPOSE, WHICH EXTEND BEYOND THOSE WARRANTIES DESCRIBED OR REFERRED TO ABOVE.

THIS LIMITED WARRANTY IS THE SOLE AND EXCLUSIVE WARRANTY MADE BY LUMINOR WITH RESPECT TO THE PRODUCT, AND IS GIVEN IN LIEU OF ANY OTHER WARRANTY. TO THE EXTENT ALLOWED BY APPLICABLE LAW, ANY AND ALL EXPRESS OR IMPLIED WARRANTIES NOT SET FORTH HEREIN ARE WAIVED AND DISCLAIMED, INCLUDING ANY IMPLIED WARRANTY OF MERCHANTABILITY OR FITNESS FOR A PARTICULAR USE. LUMINOR LIABILITY UNDER THIS LIMITED WARRANTY IS LIMITED SOLELY TO THOSE LIABILITIES SET FORTH ABOVE. IN THE EVENT THAT ANY PROVISION OF THIS LIMITED WARRANTY SHOULD BE OR BECOME INVALID OR UNENFORCEABLE UNDER APPLICABLE LAW, THE REMAINING TERMS AND CONDITIONS HEREOF SHALL REMAIN IN FULL FORCE AND EFFECT AND SUCH INVALID OR UNENFORCEABLE PROVISION SHALL BE CONSTRUED IN SUCH A MANNER AS TO BE VALID AND ENFORCEABLE.

## Warranty Registration

It is imperative that you complete the warranty registration process. This not only registers your UV disinfection\*\* system for the provided manufacturer's warranty, but also allows the factory to provide you with any important product updates or technical bulletins concerning your product. The registration process is simple and can ONLY be done online. When registering please ensure that ALL information is filled in, including a valid e-mail address. **PLEASE NOTE:** This information is for the sole purpose of technical support for your disinfection\*\* system and will not be used, or sold, to any other organization for any other purpose. Please refer to LUMINOR's Privacy Policy statement at [luminoruv.com/privacy-policy](http://luminoruv.com/privacy-policy) for further information.

## For Parts and Service Call

### **LUMINOR Environmental Inc.**

80 Southgate Dr., Unit 4

Guelph, ON, N1G 4P5

Canada

Toll-free: 1.855.837.3801

Email: [info@luminoruv.com](mailto:info@luminoruv.com)







illuminating technologies for life



80 Southgate Drive, Unit 4  
Guelph, Ontario, CANADA N1G 4P5  
P: 519-837-3800  
TF: 855-837-3801  
F: 519-837-3808  
info@luminoruv.com  
www.luminoruv.com



EPA Establishment  
#088776-CAN-001

PN: 910114  
REV E / 02-24