

LUMINOR™ RAINIER

Operation & Installation Instructions





ILLUMINATING
TECHNOLOGIES
FOR LIFE

Table of Contents

Product Matrix.....	1
Safety Considerations	2
Before You Begin.....	3
Water Quality Parameters.....	3
Assembly.....	4
System Sizing.....	5
Installation Location	5
Considerations Before Installation	6
Installation.....	7
System Preparation	9
Cleaning the quartz sleeve.....	9
Cleaning the UV sensor	10
Operation - Control Panel	11
Operation - 3-Position Switch.....	11
Operation - Power-up	12
Operation - UV Intensity.....	12
Operation - Major & Minor Alarm Set Points	13
Operation - Lamp Countdown	13
Operation - Lamp Countdown Reset.....	13
System Troubleshooting.....	14
Expansion Options	15
Specifications.....	16-17
Warranty Registration	18
Limited Warranty Statement	19

Product Matrix

SYSTEM	 "Normal" 30 mJ/cm ² @ 95% UVT	 LOW UVT 30 mJ/cm ² @ 50% UVT	 TOC 150 mJ/cm ² @ 95% UVT
1-lamp "35" series	LR5-35X	LR5-35X	LR5-35X-TOC
	LR6-35X	LR6-35X-50	LR6-35X-TOC
1-lamp "55" series	LR5-55X	LR5-55X	LR5-55X-TOC
	LR6-55X	LR6-55X-50	LR6-55X-TOC
1-lamp "85" series	LR5-85X	LR5-85X	LR5-85X-TOC
	LR6-85X	LR6-85X-50	LR6-85X-TOC
2-lamp "110" series	LR5-110X	LR5-110X	LR5-110X-TOC
	LR6-110X	LR6-110X-50	LR6-110X-TOC
2-lamp "140" series	LR5-140X	LR5-140X	LR5-140X-TOC
	LR6-140X	LR6-140X-50	LR6-140X-TOC
2-lamp "175" series	LR5-175X	LR5-175X	LR5-175X-TOC
	LR6-175X	LR6-175X-50	LR6-175X-TOC
<p style="text-align: center;"> North American 120V order with "1" suffix European CEE 7/7, 3-wire for all 230V - "2" suffix British Standard, BS 1363, 3-wire for all 230V - "3" suffix Australian/New Zealand, AS/NZ 3112, 3-wire for all 230V - "4" suffix North American, NEMA 6-15, 3 prong for all 230V - "5" suffix </p>			

Safety Considerations

It is important that care is taken when operating and/or maintaining your system.

Please read the instructions

- **Energy given off by the UV lamp is harmful to your eyes and skin. NEVER look directly at an illuminated UV lamp without adequate eye protection and always protect your skin from direct exposure to the UV light.**
- WARNING: During periods of reduced water flow, reactor may be hot.
- WARNING: Do not operate the UV-C emitter when it is removed from the appliance enclosure.
- The appliance is to be supplied through a residual current device (RCD) having a rated residual operating current not exceeding 30 mA.
- This appliance contains a UV-C emitter.
- Unintended use of the appliance or damage to the housing may result in the escape of dangerous UV-C radiation. UV-C radiation may, even in little doses, cause harm to the eyes and skin.
- The appliance must be disconnected from the supply before replacing the UV-C emitter.
- The appliance is intended to be permanently connected to the water mains and not connected by a hose-set.
- Maximum working voltage of built-in UV driver U-OUT=240V
- If the power supply cord is damaged, it must be replaced by the manufacturer, its service agent or similarly qualified persons in order to avoid a hazard.
- Before servicing this equipment, disconnect the power cord from the electrical outlet.
- Use ONLY genuine replacement parts.
- Do not operate the unit if it has any damaged or missing components.
- To avoid possible electrical shock, use only with a properly grounded electrical outlet.
- Never perform any maintenance to the system unless you are comfortable in doing so. Contact the manufacturer for service instructions if required.
- Do not use this system for any purpose other than what it was intended for. Misuse of this system could potentially cause harm to the user or others.
- Your system is intended to be installed indoors and away from leaking plumbing. DO NOT plug the unit in if the system or any of the electrical components are wet.
- The system should be directly installed into a ground fault circuit interrupter (GFCI). Please note that for 230 volt RAINIER products, special High-current GFCI's (GFI's) are required. These special GFCI's can easily be obtained through an electrical supply house, or are readily available from a local spa/hot tub supply store as they are commonly used in these applications.

- The appliance is not to be used by persons (including children) with reduced physical, sensory or mental capabilities, or lack of experience and knowledge, unless they have been given supervision or instruction.
- Children should be supervised so that they do not to play with the appliance.
- We recommend that a licensed plumber or certified technician install the system.

THIS PRODUCT IS NOT TO BE USED FOR GENERAL LIGHTING / ILLUMINATION.

Before you begin

Water Quality Parameters

Treated water should be tested for at the least the parameters listed below. If the water exceeds the listed parameters LUMINOR strongly recommends that appropriate pretreatment equipment be installed (equipment required will depend on parameters being treated):

Hardness: <7 gpg (120 mg/L) – if hardness level is 7 gpg or slightly below the quartz sleeve must be cleaned periodically in order to ensure efficient UV penetration; if above the water must be softened.

Iron (Fe): <0.3 ppm (0.3 mg/L)

Manganese (Mn): <0.05 ppm (0.05 mg/L)

Turbidity: < 1 NTU

Tannins (organics): <0.1 ppm (0.1 mg/L)

UVT (transmittance): >85% (Please contact LUMINOR if water has a UVT that is less than 80% for pre-treatment recommendations)

You can have your water tested at a private analytical laboratory or by your local dealer. It is always recommended to install pre-filtration of at least 5 microns prior to a LUMINOR UV system.

Installation Tools

- Pipe cutter, hacksaw or other specialized tools required to cut into your existing plumbing (e.g. if you have PEX piping)
- Soldering tools (torch, flux, emery cloth and solder)
- Wrench (for tightening fittings)
- Inlet/outlet connections
- Teflon™ tape

Assembly

Unpack the system and ensure all the components are included with the system. Your System is shipped with the following components:

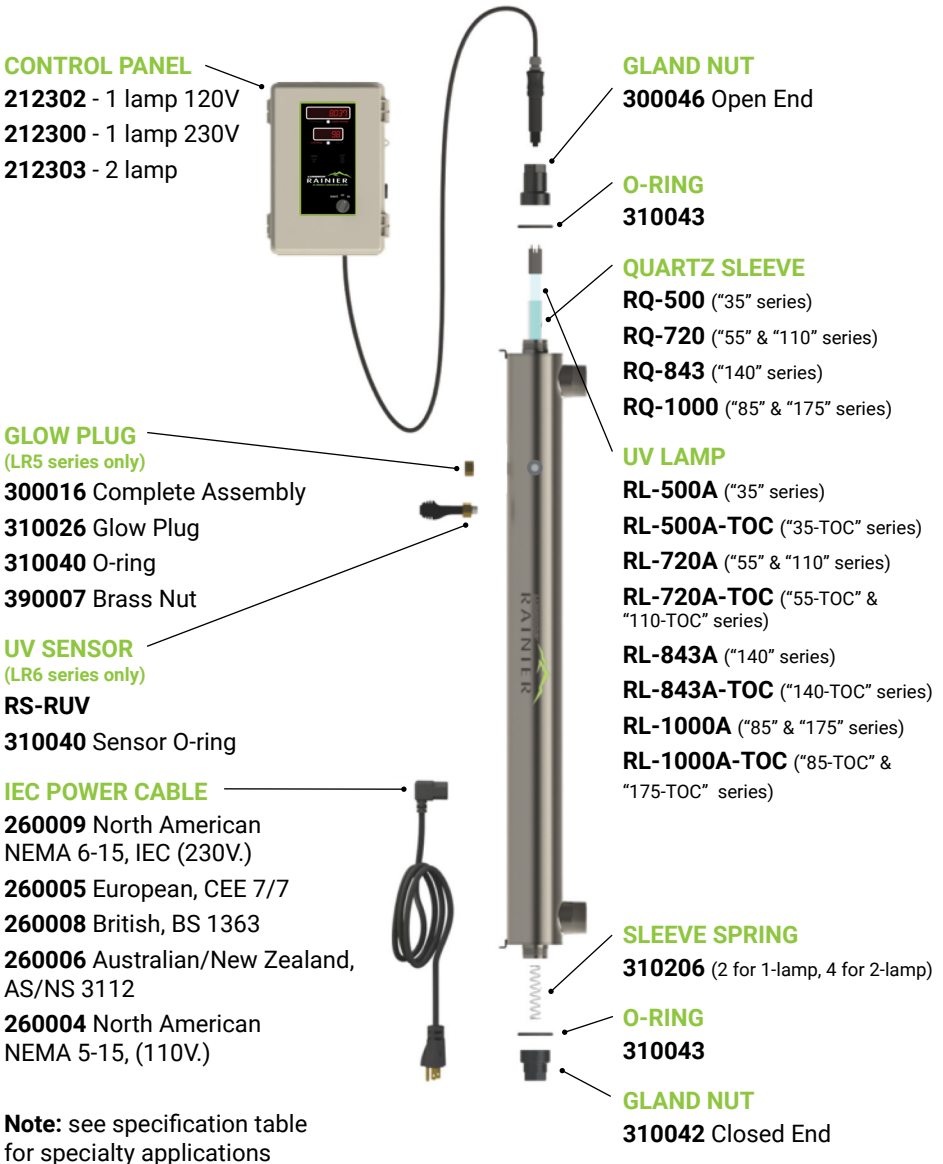

Note: see specification table for specialty applications

Figure 1. RAINIER System Components

System Sizing

All LUMINOR UV systems are rated for a specific flow rate in water that meets the quality parameters. **PLEASE NOTE:** increasing the flow above this rating or treating water that does not meet the quality parameters will decrease the dose and therefore compromise the efficacy of the system.

If you need to determine your maximum flow rate, you can fill a 1 gallon bucket with water and time how long it takes to fill up. It is always better to oversize your system than to undersize. For example, if your pump delivers 40GPM, it is recommended to install a RAINIER 58 GPM system.

Installation Location

Find a suitable location to mount the UV reactor and the accompanying control panel. In choosing your location ensure that the panel is located within 5 feet of a ground fault circuit interrupter (GFCI) and that there is easy access to the main cold water line prior to any branch lines and before the hot water heater. If you have any other water treatment equipment, such as a softener or water filter, ensure that the UV is the last piece of treatment equipment. **PLEASE NOTE:** All LUMINOR UV systems are intended for indoor use only as they should not be exposed to the elements.

There are two different sizes of RAINIER control panels, depending on which system is purchased. See Figure 2 below for 1-lamp systems, Figure 3 for 2-lamp systems.

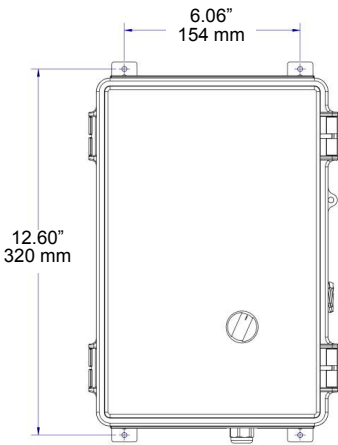

Figure 2. 1-Lamp Systems

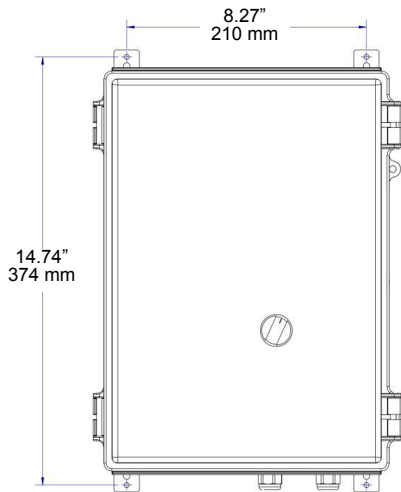

Figure 3. 2-Lamp Systems

To facilitate lamp removal, ensure there is enough space on the end with the open gland nut to safely remove the UV lamp and/or quartz sleeve (a space equal to the length of the unit will suffice) (see Figure 4).

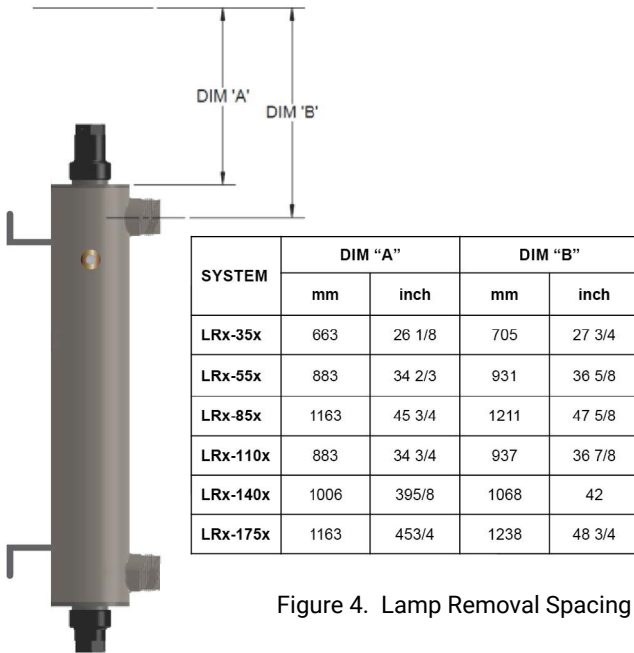

Figure 4. Lamp Removal Spacing

PLEASE NOTE: ALL LUMINOR UV SYSTEMS ARE INTENDED FOR INDOOR USE ONLY AS THEY SHOULD NOT BE EXPOSED TO THE ELEMENTS.

Considerations Before Installation

- The UV system should always be the last piece of treatment before the water branches off to any hot or cold water lines.
- LUMINOR strongly recommends that a 5 micron filter be installed before the UV system for a final polishing step before the water is treated.
- The reactor can be installed either horizontally or vertically, however vertical installation is the preferred method with the inlet at the bottom (lamp connection at the top) as it allows any air that may be in the lines to be easily purged from the UV system.
- If you do not know the flow rate of the water supply in the application, it is recommended that you use a flow restrictor so that the rated flow of your particular RAINIER system is not exceeded and the UV dose is not compromised. The flow restrictor should be installed on the outlet port of the reactor.

- It is strongly recommended to have a licensed plumber connect the UV reactor to the water supply and may be a requirement depending on where you are located. If you are attempting this yourself, ensure you have all the necessary tools and fittings to accomplish this task.
- Although there are many methods of installation, this manual will provide a recommended procedure using copper plumbing and standard soldering methods. LUMINOR recommends the use of unions, a bypass assembly and shut-off valves as this will allow you to isolate and remove the UV reactor if necessary (this is a recommended method only as it allows for the maximum convenience but it requires extra components and more time for installation).

Installation

Step 1: Before you cut into the cold water line, measure and cut all piping as per the recommended layout. Once all the components are ready, start by installing the female adapters onto the ports of the reactor. To ensure a proper seal, the use of Teflon™ tape is recommended on all threaded connections.

Step 2: Solder whole assembly together; including ball valves and unions. Connect the bypass assembly to the cold water feed line (water in and water out).

Step 3: **Skip this step if the system arrived with the quartz sleeve(s) installed.** Once the system has been plumbed in, gently remove the quartz sleeve from its packaging using cotton gloves. Carefully slide the sleeve into the reactor, ensuring that it is centered, until it is all the way through the reactor and the amount of sleeve is even on both sides. Slide one O-ring onto each side of the sleeve, until they are butted up against the reactor. Repeat this step for the second sleeve on a 2-lamp system.

Step 4: Install the UV sensor (if applicable). Align the flat portion so it faces the gland nut end and matches up with the half metal lip on the sensor port (see Figure 6). Insert the sensor so it is fully seated and hand tighten the sensor nut.

Step 5: Hand tighten the provided gland nut over the quartz sleeve onto the threaded end of the reactor. It has a positive stop to prevent over-tightening. A firm force may be required to fully tighten the gland nut, but DO NOT USE TOOLS for this step. Insert the provided stainless steel compression spring into the quartz sleeve. The spring works with the lamp and LUMI-Loc™ connector to create the proper lamp alignment. PLEASE NOTE: DO NOT install a UV lamp inside the quartz sleeve without the sleeve spring in place. Plug the male connector into the sensor port located on the bottom of the control panel, (see Figure 7),



Figure 5. Quartz Sleeve Installation

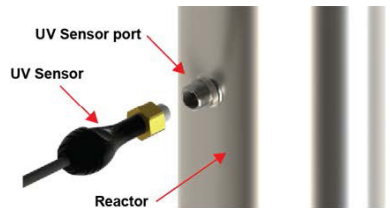

Figure 6. UV Sensor Installation

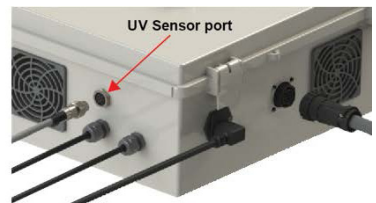

Figure 7. Sensor Connection

Step 5: The reactor is now ready for water flow. When all plumbing connections have been completed you should check for any possible leaks. Slowly turn on the water supply and check for leaks. Make sure that any bypass valves are functioning properly and that the water is flowing through the reactor. The most common leak is from the o-rings not making a proper seal on the reactor. If this is the case turn the water off, drain the reactor, remove each o-ring, dry them and reapply silicon grease. Replace each o-ring ensuring they are properly sealed against the reactor, re-tighten the gland nuts and check again for leaks.

Step 6: Mount the control panel to the wall so it is above or beside the reactor, to ensure that no moisture can deposit on any of the connections. The control panel can be mounted up to 8 feet away from the reactor.

Step 7: Using cotton gloves, remove the lamp from its packaging, making sure to only touch the ceramic ends of the lamp. Insert the UV lamp into the reactor, being careful not to drop it. Repeat this step for a 2-lamp system.

Step 8: Plug the LUMI-Loc™ lamp connector into the lamp, being careful to not crack the ceramic. Note the keying for proper alignment (see Figure 8). Insert the lamp connector into the gland nut and turn the connector approximately 1/4 turn to lock the connector to the gland nut (see Figure 9)

***Note:** Repeat Steps 7 & 8 for 2-lamp system.



Figure 8.
UV Lamp
Connection



Figure 9.
LUMI-Loc™
Connector

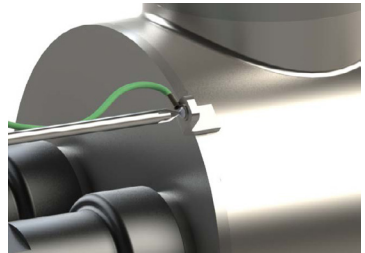

Figure 10. Ground Screw
Connection

Step 9: Affix the ground wire to the ground lug on the UV reactor to ensure proper grounding continuity (see Figure 10).

Step 10: Your system is now ready to be plugged into the appropriate GFCI protected outlet. Refer to the following section before any water is allowed to flow through the system.

Step 11: Affix “Danger: Hot” label to the reactor.

Care & Maintenance

System Preparation

With a new installation, or any time the UV system is shut down for service, without power, or is inoperative for any other reason, the lines in the home or facility could be contaminated. Use the following steps to prepare the lines throughout the entire facility.

Step 1: Check for and remove any “dead ends” in the lines throughout the home as these can harbor dirt and debris. Plug in the UV system and wait until it is ready for operation.

Step 2: Remove the filter cartridge from the last sump and fill it with 1-2 cups of household bleach (most are 5.25% chlorine). Replace the sump and slowly turn on the water supply.

Step 3: At a water outlet, run the water until bleach can be smelled. Repeat this for all faucets, toilets, shower heads, refrigerators, outdoor taps, the washing machine, dishwasher, etc. at the home or facility. Once finished, wait a minimum of 30 minutes before continuing.

Step 4: Reinstall the filter cartridge into the sump and flush the chlorine solution by opening all faucets until chlorine can no longer be detected. Your UV system is ready to use.

Cleaning the Quartz Sleeve

Depending on the water quality, the quartz sleeve may require periodic cleaning. At a minimum, the quartz sleeve should be cleaned on an annual basis. The following steps outline a basic cleaning procedure.

Step 1: If a bypass assembly is installed, shut the inlet valve off to prevent water flow through the system. Otherwise, turn off main water inlet valve (and/or turn off the water pump).

Step 2: Disconnect power cord of UV system from electrical outlet.

Step 3: Release water pressure by opening a downstream faucet and then close the outlet shut-off valve (if any). If there is no outlet shut-off valve, expect water to drain from the system as the head pressure in the system will cause the water to flow back down.

Step 4: Remove the captive ground screw from the ground lug on the UV reactor.

Step 5: Remove the lamp connector(s) from the reactor (gland nut) by pushing the LUMI-Loc™ connector in and turning it ¼ turn counter-clockwise. Disconnect the lamp connector(s) from the lamp(s). **CAUTION: the lamp(s) may be hot!**

Step 6: Being careful to touch only the ceramic ends, remove the lamp from the reactor.

Step 7: Unscrew the gland nuts from the reactor, exposing the ends of the quartz sleeve(s).

Step 8: While holding on to both ends of the sleeve carefully remove the o-ring from the end opposite from the lamp connection and then pull the quartz sleeve out of the reactor (ensure that no water enters the inside of the quartz sleeve); remove second o-ring

Step 9: Using a soft, lint-free cloth or towel, wipe the sleeve down using a commercial scale cleaner (i.e. CLR® or LIME-A-WAY®). This removes scaling or iron deposits that may be on the outside of the quartz sleeve. Be careful not to get any moisture or liquids inside of the sleeve.

Step 10: Dry the sleeve with separate cloth.

Step 11: Place the sleeve(s) back into the reactor following step 4 from installation section.

Cleaning the UV Sensor

Depending on the water quality, the UV sensor may require periodic cleaning. At a minimum, the UV sensor should be cleaned on an annual basis. The following steps outline a basic cleaning procedure.

Step 1: If a bypass assembly is installed, shut the inlet valve off to prevent water flow through the system. Otherwise, turn off the main water inlet valve (and/or turn off the water pump).

Step 2: Disconnect power cord of UV system from electrical outlet.

Step 3: Release water pressure by opening a downstream faucet and then close the outlet shut-off valve (if any). If there is no outlet shut-off valve, expect water to drain from the system as the head pressure in the system will cause the water to flow back down.

Step 4: Place something under the reactor to catch any water that may come out of the reactor during the removal of the UV sensor.

Step 5: Unscrew (counterclockwise) sensor nut from the reactor and pull the sensor slowly out of the sensor port.

Step 6: Holding the sensor in your hand, wipe the flat portion (sensor face) of the sensor with isopropyl alcohol using a clean, lint-free cloth.

Step 7: Replace sensor following step 5 from the installation section of the manual.

CAUTION: PRIOR TO PERFORMING ANY MAINTENANCE ON YOUR UV SYSTEM, YOU MUST ALWAYS DISCONNECT THE POWER (DO NOT SIMPLY USE THE SWITCH ON THE FRONT OF THE CONTROL PANEL).



Operation

The RAINIER system comes with a feature laden control system that incorporates both the lamp driver (ballast) and control features in one modular panel. The LED display indicates remaining lamp life and total running hours, and has audible and visual warnings for lamp failure. With the remote monitoring cable, the controller supports a remote-on function, a 4-20mA status output and system ready, system fault dry contacts making it solenoid ready.

RAINIER 3-Position Switch

The control panel features a 3-position user-selectable switch. This switch is NOT a power switch and it should be noted that once the control panel is plugged into an electrical outlet, the unit is powered and considered "ON". The switch functions as follows:

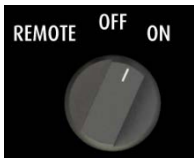

"ON" position

Power is supplied to the lamp(s) and the control panel will read "ON" on the lower LED display on units without a UV sensor installed and will read the intensity (or UV output) on units with a UV sensor installed.



"OFF" position

Power is NOT supplied to the lamp(s) and the lamp(s) will be off. The control panel will read "OFF" on the lower LED display.

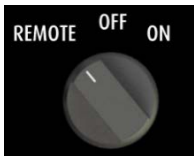

"REMOTE" position

In this position, the control of the unit is placed in a remote location (i.e. a computer) via an attached remote monitoring cable (order PN 210010). Through this cable, the operator must supply a 24 volt power source that will allow these "dry contacts" to operate. The screens and the "ON" and "OFF" functions will now all be operated remotely. While the UV control panel is in the remote position, **EXTREME CAUTION** must be exercised around the UV reactor while servicing the UV lamps as they may be turned on or off remotely without the operators knowledge or control.



Power-up Sequence

Upon start up, the bottom LED on your RAINIER control panel will countdown from 180 seconds as the system powers on. Once the countdown is finished, the UV system is ready for use.

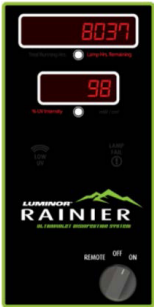

UV Output (RAINIER 6.0)

If your system is equipped with a UV sensor, your RAINIER control panel will display the UV output in “% UV Intensity” or “mW/cm²”. The default output is “% UV Intensity” and to toggle between these two outputs, simply press the button located directly beneath the bottom LED screen. The LED screen will indicate the level of UV intensity that is being detected within the reactor by the sensor. Things that can affect the UV Output negatively are poor water quality, scaling of the quartz sleeve and/or sensor, lamp failure, expired lamp life and sensor failure.

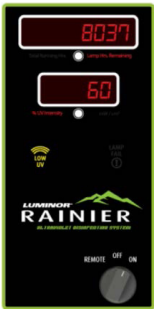

When the UV output drops to ~60%, the system will display a “LOW UV” warning light in yellow and the system will emit an intermittent audible chirp. When the UV output drops to ~50% the system will display a “LOW UV” warning light in red and the system will emit a constant audible alarm. Values below 50% may be unsafe for consumption. Additionally, at this point, the control panel also provides a signal to de-activate the flow of water if implemented in the system. When the system registers a low UV condition, the only way to silence the alarms is to correct the reason for this low UV condition.

If the LED reads “OFF” then the water from the system may be unsafe for consumption. If any water does pass through the UV system during this period, please follow the preparation procedure as outlined in this manual before the water is consumed.

The RAINIER LR5 system does not measure the level of disinfection; it simply measures the “ON-OFF” status of the lamp. Please have your water checked for microbiological contaminants on a regular basis.

Major Alarm Set Points:

System No. of Lamps	SYSTEM	Intensity (mW/cm ²)	UVI(%)
1	Regular, TOC, HW	17	50
1	Low UVT	13	50
2	Regular, TOC, HW	15	50
2	Low UVT	10	50

Minor Alarm Set Points

System No. of Lamps	SYSTEM	Intensity (mW/cm ²)	UVI(%)
1	Regular, TOC, HW	20.3	58
1	Low UVT	15.6	60
2	Regular, TOC, HW	18	60
2	Low UVT	12	60

Lamp Countdown Sequence

The RAINIER control panel displays a countdown feature that displays the number of hours remaining until a lamp change is required. At 512 hours until lamp change the numerical lamp change value will begin to flash indicating that lamp expiration is near. At "zero hours remaining", the system registers an audible alarm. If you wish to silence this audible alarm, simply press and hold down the button located directly beneath the top LED screen for three seconds. **PLEASE NOTE:** During the condition of lamp expiration, the water may be unsafe for consumption.



Lamp Replacement

After the lamp is expired, it must be replaced with the same part number as indicated by the label on the reactor. Begin replacing the lamp by unplugging the power for the controller, then refer to Installation for instructions on installing the new lamp. After changing the lamp on the RAINIER systems, the control panel must be reset in order for the system to begin its countdown function on the newly installed lamp. To reset, simply press and hold down the button located directly beneath the top LED screen for fifteen seconds. Release the button and then unplug & plug the system back in. The lamp countdown timer has now been reset.

***After lamps are expired, they must be replaced with the same part number as indicated on the label on the reactor (see steps 7 & 8 on page 8 for how to replace the lamp).**

System Troubleshooting

The RAINIER control panel continuously monitors your UV system and if there is a problem with the system the panel will provide both a visual and audible signal indicating the specific fault that it is detecting. The fault conditions are listed in a priority sequence as follows:

System Display	Problem	Resolution
	<p>The system has detected a problem with the lamp.</p>	<p>Replace lamp If that does not resolve the alarm, replace ballast.</p>
	<p>The UV sensor is no longer communicating with the system.</p>	<ol style="list-style-type: none"> 1. Unplug controller from outlet and sensor from controller 2. Plug sensor back in and restart system 3. If FAIL is still displayed, replace sensor

Expansion Options

Although features such as remote-on, system ready and fault dry contacts, and 4-20 mA output are built into the control panel, they require an optional cable as below.

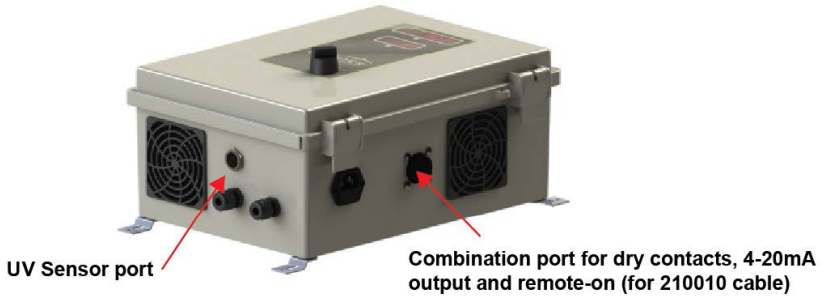

Remote Monitoring Cable (for both 4-20mA and remote monitoring options) Part # 210010
Includes connector and 10m (33') of cable to provide both a 4-20 mA signal, dry contacts for system ready, fault signals and 24V DC remote-on input to a remote location.

Contact your authorized distributor for purchasing information.



LUMINOR EQUIPMENT SPECIFICATIONS

RAINIER, Light Commercial Amalgam UV systems

MODEL ¹ (See "Plug Type" for all 230 volt variants)	LR5 (non-monitored)		LRX-355 LRX-355-50 LRX-355-TOC	LRX-555 LRX-555-50 LRX-555-TOC	LRX-855 LRX-855-50 LRX-855-TOC	LRX-1105 LRX-1105-50 LRX-1105-TOC	LRX-1405 LRX-1405-50 LRX-1405-TOC	LRX-1755 LRX-1755-50 LRX-1755-TOC
	LR6 (UV-monitored)							
Normal Flow Rate 30 ml/cm ² @ 95% UVT			35 GPM (132 lpm) (7.9 m ³ /hr.)	55 GPM (208 lpm) (12.5 m ³ /hr.)	85 GPM (322 lpm) (19.3 m ³ /hr.)	140 GPM (530 lpm) (31.8 m ³ /hr.)	180 GPM (681 lpm) (40.9 m ³ /hr.)	215 GPM (814 lpm) (48.8 m ³ /hr.)
Hot Water Flow Rate 30 ml/cm ² @ 75% UVT			22 GPM (90 lpm) (5.0 m ³ /hr.)	38 GPM (150 lpm) (9.0 m ³ /hr.)	55 GPM (208 lpm) (11.6 m ³ /hr.)	75 GPM (283 lpm) (17.0 m ³ /hr.)	95 GPM (360 lpm) (21.6 m ³ /hr.)	115 GPM (435 lpm) (26.1 m ³ /hr.)
LOW UVT Flow Rate 30 ml/cm ² @ 50% UVT			14 GPM (53 lpm) (3.2 m ³ /hr.)	23 GPM (87 lpm) (5.2 m ³ /hr.)	35 GPM (132 lpm) (7.9 m ³ /hr.)	39 GPM (148 lpm) (8.9 m ³ /hr.)	49 GPM (185 lpm) (11.1 m ³ /hr.)	60 GPM (227 lpm) (13.6 m ³ /hr.)
TOC Flow Rate 150 ml/cm ² @ 98% UVT			7 GPM (26 lpm) (1.6 m ³ /hr.)	12 GPM (45 lpm) (2.7 m ³ /hr.)	17 GPM (64 lpm) (3.9 m ³ /hr.)	31 GPM (117 lpm) (7.0 m ³ /hr.)	40 GPM (151 lpm) (9.1 m ³ /hr.)	48 GPM (182 lpm) (10.9 m ³ /hr.)
Alternate flow @ 16 ml/cm² at 95% UVT (US Public Health)			66 GPM 1 (250 lpm 1) (15.0 m ³ /hr. 1)	109 GPM 2 (413 lpm 2) (24.8 m ³ /hr. 2)	167 GPM 2 (632 lpm 2) (37.9 m ³ /hr. 2)	266 GPM 3 (1007 lpm 3) (60.4 m ³ /hr. 3)	337 GPM 4 (1276 lpm 4) (76.5 m ³ /hr. 4)	406 GPM 5 (1537 lpm 5) (92.2 m ³ /hr. 5)
Alternate flow @ 40 ml/cm² at 95% UVT			26 GPM (98 lpm) (5.9 m ³ /hr.)	44 GPM (167 lpm) (10.0 m ³ /hr.)	57 GPM (216 lpm) (12.9 m ³ /hr.)	106 GPM (401 lpm) (24.1 m ³ /hr.)	135 GPM (511 lpm) (30.7 m ³ /hr.)	163 GPM (617 lpm) (37.0 m ³ /hr.)
Port Size			1 ½" MNPT	2" MNPT	2" MNPT	2 ½" MNPT	3" MNPT	4" MNPT
Electrical			110V/60Hz. or 230V/50-60Hz. (IEC power cords required)	[MUST specify voltage when ordering]				
Power Plug			North American, 120V order with "1" suffix European, CEE 7/7, 3-wire for all 230V - "2" suffix British Standard, BS 1363, 3-wire for all 230V - "3" suffix Australian/New Zealand, AS/NZ 3112, 3-wire for all 230V - "4" suffix North American, NEMA 6-15, 3 prong for all 230V - "5" suffix					

Lamp Watts	104	152	207	304	344	414
Power (watts)	120	170	220	320	360	430
Replacement Lamp (disinfection @ 254 nm)	RL-500A (1 used)	RL-720A (1 used)	RL-1000A (1 used)	RL-720A (2 used)	RL-843A (2 used)	RL-1000A (2 used)
Replacement Lamp (TOC @ 185 nm)	RL-500A-TOC (1 used)	RL-720A-TOC (1 used)	RL-1000A-TOC (1 used)	RL-720A-TOC (2 used)	RL-843A-TOC (2 used)	RL-1000A-TOC (2 used)
Replacement Sleeve	RQ-500 (1 used)	RQ-720 (1 used)	RQ-1000 (1 used)	RQ-720 (2 used)	RQ-843 (2 used)	RQ-1000 (2 used)
Chamber Material	316L Stainless Steel, A249 Pressure Rated Tubing, Polished & Passivated					
Control Panel Dimensions	11.8 x 7.9 x 6.3" (30.0 x 20.0 x 16.0 cm)		15.8 x 11.8 x 6.3" (40.0 x 30.0 x 16.0 cm)			
Reactor Dimensions	4 x 27.2 x 5.6" (10 x 69 x 14 cm)		4 x 35.8 x 5.6" (10 x 91 x 14 cm)		6 x 46.8 x 7.9" (15 x 119 x 20 cm)	
Maximum Operating Pressure	10.3 bar (150 psi)					
Optimum Water Temperature	2-40° C (36-104° F)					
254nm UV Intensity Monitor	YES (on LR6 series) Upgradeable (on LR5 series)					
Remote-On	YES (requires optional 210010 cable assembly sold separately)					
Dry Contacts (solenoid ready)	YES (requires optional 210010 cable assembly sold separately)					
4-20 mA Output	YES (requires optional 210010 cable assembly sold separately)					
Temperature Management Valve	130034 NA					
Cooling Fan	YES (optional 130018 (NA), 130019 (Euro), 130020 (British), 130021 (Australia/NZ))					
Lamp Age Counter	YES					
Visual Lamp-Out Indicator	YES					
Audible Lamp-Out Alarm	YES					
Shipping Weight	Call factory	Call factory	Call factory	Call factory	Call factory	Call factory

Note: 1. Based on flow velocity of 8.2 ft/sec (2.5 m/sec), flow rate limited to **62 gpm** (197 lpm) (11.8 m³/hr) for 1 ½" port
2. Based on flow velocity of 8.2 ft/sec (2.5 m/sec), flow rate limited to **103 gpm** (325 lpm) (19.5 m³/hr) for 2" port
3. Based on flow velocity of 8.2 ft/sec (2.5 m/sec), flow rate limited to **146 gpm** (463 lpm) (27.8 m³/hr) for 2 ½" port
4. Based on flow velocity of 8.2 ft/sec (2.5 m/sec), flow rate limited to **226 gpm** (715 lpm) (42.9 m³/hr) for 3" port
5. Based on flow velocity of 8.2 ft/sec (2.5 m/sec), flow rate limited to **389 gpm** (1232 lpm) (73.9 m³/hr) for 4" port

Flow rates for lower doses may not be achievable.
Contact factory for custom port sizing.
Our sizing is based on standard ideal average dose calculation and 80% lamp efficiency at end of life.
NOTE: Electrical certification optional for various markets.

Limited Warranty Statement:

Products manufactured by LUMINOR Environmental Inc., (LUMINOR) are warranted to the original user only to be free of defects in material and workmanship for a period as specified below. This warranty only applies to the original purchaser and is not transferable.

UV SYSTEMS

Ten (10) year Limited Warranty on the stainless steel reactors, from the date of original purchase, or installation (proper documentation required for verification).

ELECTRONICS

Three (3) year Limited Warranty on the ballasts and control panels, from the date of original purchase, or installation (proper documentation required for verification).

UV LAMPS, UV SENSORS & QUARTZ SLEEVES

One (1) year Limited Warranty on all LUMINOR ultraviolet lamps, UV sensors and quartz sleeves from the date of original purchase, or installation (proper documentation required for verification).

LUMINOR warrants that it will repair, replace or refund, at LUMINOR's sole option, any ultraviolet system or component that is defective in materials or workmanship for the period as outlined above, subject to the "Limitations of Warranty" as outlined below. LUMINOR's liability under this warranty shall be limited to repairing or replacing at LUMINOR's option, without charge, F.O.B. LUMINOR's factory or authorized service depot, any product that LUMINOR manufactures. LUMINOR will not be liable for any costs of removal, installation, transportation, or any other charges which may arise in connection with a warranty claim. Products which are sold but not manufactured by LUMINOR are subject to the warranty provided by the manufacturer of said products and not by LUMINOR's warranty. LUMINOR will not be liable for damage or wear to products caused by abnormal operating conditions, accident, abuse, misuse, unauthorized alteration or repair, or if the product was not installed in accordance with LUMINOR's printed installation and operating instructions.

LIMITATIONS OF WARRANTY

This warranty does not apply to any of the following:

- Water Quality Parameters lie outside of the following ranges
 - Hardness > 120 mg/L (7 gpg)
 - Iron > 0.3 mg/L (ppm)
 - Manganese > 0.05 mg/L (ppm)
 - Tannins > 0.1 mg/L (ppm)
 - Turbidity > 1 NTU
 - Transmittance (UVT) < 75%
- A product that has been incorrectly installed according to the technical installation manual.
- A product that has been modified in any manner, unless approved by the manufacturer.
- A product where the serial number has been altered defaced or removed.
- Damage caused by the use of parts that are not compatible, suitable and/or authorized by LUMINOR for use with the product (e.g. non-original lamps or sleeves).

- Damage caused during shipment of the product.
- Water damage is found inside ballast housing or control panels.
- Product is installed outdoors in direct contact with the environment (rain).
- Product is installed in freezing temperatures.
- Product is used in conditions that exceed LUMINOR's specifications.

TO GET WARRANTY SERVICE

To obtain service under this warranty, you must first contact LUMINOR Customer Service at 855-837-3801 (519-837-3800 outside of the US or Canada) to obtain a Warranty Return Authorization. You will then need to return the product through the LUMINOR Dealer or Distributor where the product was originally purchased, together with proof of purchase and installation date, failure date, and supporting installation data. Unless otherwise provided, the Dealer or Distributor will contact LUMINOR for instructions on returning the product. Any defective product to be returned to LUMINOR must be sent freight prepaid; documentation supporting the warranty claim and/or a Return Material Authorization must be included if so instructed.

LUMINOR WILL NOT BE LIABLE FOR ANY INCIDENTAL OR CONSEQUENTIAL DAMAGES, LOSSES, OR EXPENSES ARISING FROM INSTALLATION, USE, OR ANY OTHER CAUSES. THERE ARE NO EXPRESS OR IMPLIED WARRANTIES, INCLUDING MERCHANTABILITY OR FITNESS FOR A PARTICULAR PURPOSE, WHICH EXTEND BEYOND THOSE WARRANTIES DESCRIBED OR REFERRED TO ABOVE.

THIS LIMITED WARRANTY IS THE SOLE AND EXCLUSIVE WARRANTY MADE BY LUMINOR WITH RESPECT TO THE PRODUCT, AND IS GIVEN IN LIEU OF ANY OTHER WARRANTY. TO THE EXTENT ALLOWED BY APPLICABLE LAW, ANY AND ALL EXPRESS OR IMPLIED WARRANTIES NOT SET FORTH HEREIN ARE WAIVED AND DISCLAIMED, INCLUDING ANY IMPLIED WARRANTY OF MERCHANTABILITY OR FITNESS FOR A PARTICULAR USE. LUMINOR LIABILITY UNDER THIS LIMITED WARRANTY IS LIMITED SOLELY TO THOSE LIABILITIES SET FORTH ABOVE. IN THE EVENT THAT ANY PROVISION OF THIS LIMITED WARRANTY SHOULD BE OR BECOME INVALID OR UNENFORCEABLE UNDER APPLICABLE LAW, THE REMAINING TERMS AND CONDITIONS HEREOF SHALL REMAIN IN FULL FORCE AND EFFECT AND SUCH INVALID OR UNENFORCEABLE PROVISION SHALL BE CONSTRUED IN SUCH A MANNER AS TO BE VALID AND ENFORCEABLE.



LUMINOR Environmental Inc.

80 Southgate Drive, Unit 4, Guelph, Ontario, CANADA N1G 4P5
Phone: (519) 837-3800 | Toll Free: (855) 837-3801 | Fax: (519) 837-3808
info@luminoruv.com
www.luminoruv.com



LUMINOR Environmental



LuminorUV



LuminorUV



EPA Establishment
#088776-CAN-001

PN: 910008
RevE / 05-24